

**R** REAR PANEL MOUNTING

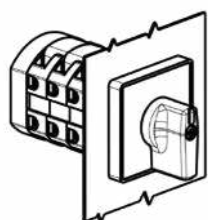

12A - 16A - 20A

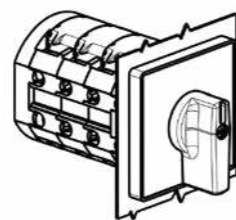

25A - 32A - 40A

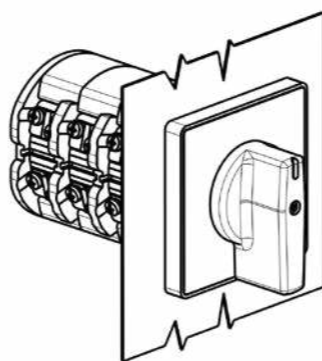

63A - 80A

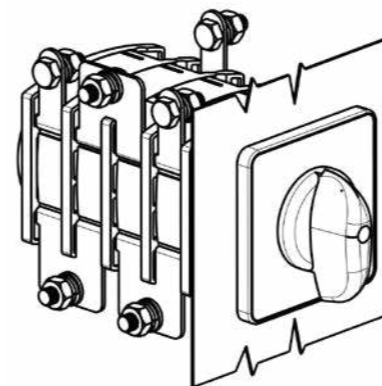

125A

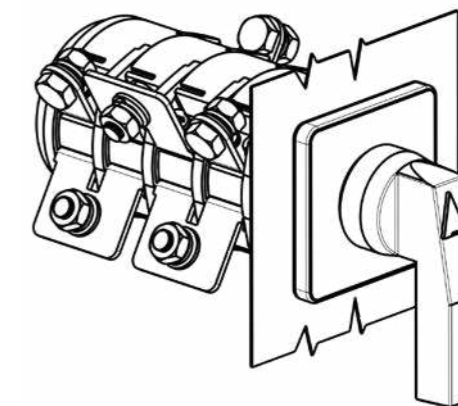

200A

**B** BASE MOUNTING

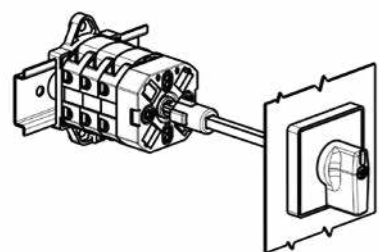

12A - 16A - 20A

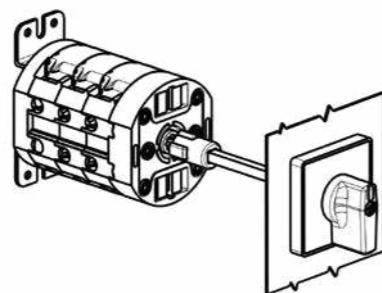

25A - 32A - 40A

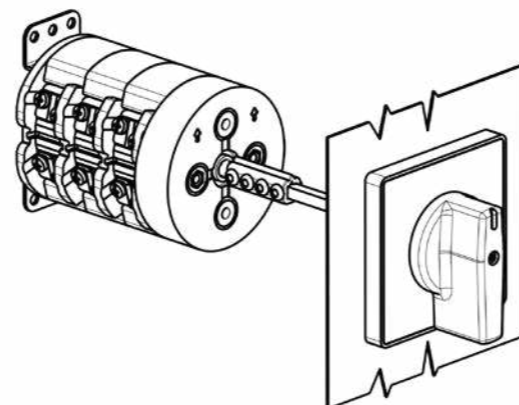

63A - 80A

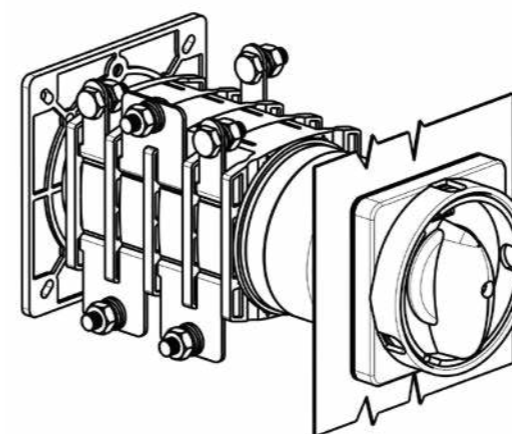

125A

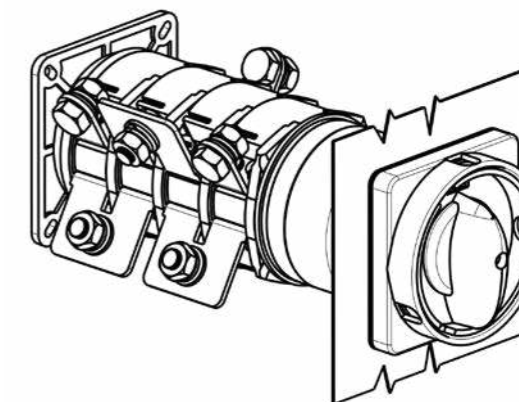

200A

**D** DIN MOUNTING 46 mm  
Only switches DIN RAIL mounting 46 mm standard boxes

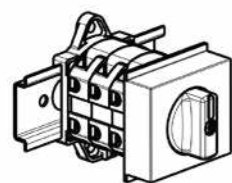

12A - 16A - 20A

**GENERAL CHARACTERISTICS**

**CAM SWITCHES - PHOENIX SERIES**

The cam switches PHOENIX Series are manufactured in compliance with the strictest international and European standards (IEC/EN 60947-3, UL508) and thus satisfy all the strict safety needs. The long industrial experience, together with the use of the best materials, to knowledge and the most modern machinery and project devices allow us to produce a range of equipment with compact dimensions, and very high quality, by placing **Giovvenzana** as a benchmark for warranty, functioning safety and product durability.



**TYPE OF MOUNTINGS**



Rear Panel Mounting



Base Mounting



Din Mounting 46 mm  
Only switches DIN RAIL mounting 46 mm standard boxes

**RANGE (AC21A)**

12-16-20-25-32-40-63-80-125-200A

**INSULATION VOLTAGE**

690V

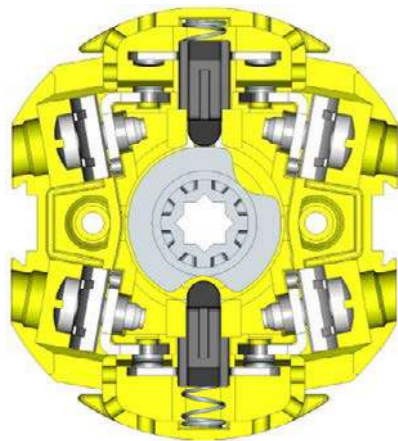

**MORE PERFORMANCES!**

- Self cleaning pads
- Silver alloy plated pads
- Available gold plated pads
- UL94 Vo class self-extinguishing thermoplastic housing
- Metal shaft, metal rods
- Finger-proof terminal version available till to 40A
- Laser engraved body switch markings
- Laser engraved actuator's plate

**APPLICATIONS**

<b>ON-OFF SWITCHES 0-1</b>	<b>CHANGEOVER SWITCHES 1-0-2</b>	<b>STEP SWITCHES</b>
<b>STAR-DELTA MOTOR SWITCHES</b>	<b>REVERSING MOTOR SWITCHES</b>	<b>SPECIAL CUSTOMIZED SCHEME ON DEMAND</b>
<b>AMMETER SWITCHES</b>	<b>VOLTMETER SWITCHES</b>	

**UTILIZATION CATEGORIES for alternate and direct current**

CATEGORY	APPLICATIONS
AC21A	Switching of resistive loads, including moderate overloads
AC22A	Switching of mixed resistive and inductive loads, including moderate overloads
AC23A	Switching of motor loads or other highly inductive loads
AC3	Squirrel-cage motors: starting, switches off motors during running time
DC21A	Switching of resistive loads, including moderate overloads
DC22A	Switching of mixed resistive and inductive loads, including moderate overloads









**PROTECTION CLASS (IEC/EN 60529)**









PARTS		WATER	
0	Non-protected.	0	Non-protected.
1	Protected against solid foreign objects of 50 mm ø and greater. The object probe, sphere of 50 mm ø shall not fully penetrate.	1	Protected against vertically falling water drops. Vertically falling drops shall have no harmful effects.
2	Protected against solid foreign objects of 12,5 mm ø and greater (ex. finger). The object probe, sphere of 12,5 mm ø shall not fully penetrate.	2	Protected against vertically falling water drops when enclosure tilted up to 15°. Vertically falling drops shall have no harmful effects when the enclosure is tilted at any angle up to 15° on either side of the vertical.
3	Protected against solid foreign objects of 2,5 mm ø and greater. The object probe, sphere of 2,5 mm ø shall not fully penetrate.	3	Protected against spraying water. Water sprayed at an angle up to 60° on either side of the vertical shall have no harmful effects.
4	Protected against solid foreign objects of 1,0 mm ø and greater. The object probe, sphere of 1,0 mm ø shall not fully penetrate.	4	Protected against splashing water. Water splashed against the enclosure from any direction shall have no harmful effects.
5	Dust-protected. Ingress of dust is not totally prevented, but dust shall not penetrate in a quantity to interfere with satisfactory operation of the apparatus or to impair safety.	5	Protected against water jets. Water projected in jets against the enclosure from any directions shall have no harmful effects.
6	Dust-tights. No ingress of dust.	6	Protected against powerful water jets. Water projected in powerful jets against the enclosure from any direction shall have no harmful effects.
		6K	Protected against powerful water jets with increased pressure. Water projected in powerful jets against the enclosure from any direction, under elevated pressure, shall have no harmful effects (DIN 40050 and not IEC 60529).
		7	Protected against the effects of temporary immersion in water. Ingress of water in quantities causing harmful effects shall not be possible when the enclosure is temporarily immersed in water under standardized conditions of pressure and time.
		8	Protected against the effects of continuous immersion in water. Ingress of water in quantities causing harmful effects shall not be possible when the enclosure is continuously immersed in water under conditions which shall be agreed between manufacturer and user but which are more severe than for numeral 7.

**BODIES RANGE OVERVIEW**





**| RANGE AC21A | 12A - 16A - 20A |**

REAR PANEL MOUNTING	BASE MOUNTING	DIN MOUNTING	TERMINAL PROTECTION	
			IP	CODE
				<b>PO</b>
				<b>PX</b>
			IP10	





**| RANGE AC21A | 25A - 32A - 40A |**

REAR PANEL MOUNTING	BASE MOUNTING	TERMINAL PROTECTION	
		IP	CODE
			<b>CO</b>
			<b>CX</b>
		IP10	





**| RANGE AC21A | 63A - 80A |**

REAR PANEL MOUNTING	BASE MOUNTING	TERMINAL PROTECTION	
		IP	CODE
			<b>CO</b>
		IP00	

**| RANGE AC21A | 125A |**

REAR PANEL MOUNTING	BASE MOUNTING	TERMINAL PROTECTION	
		IP	CODE
			<b>G</b>
		IP00	

**| RANGE AC21A | 200A |**

REAR PANEL MOUNTING	BASE MOUNTING	TERMINAL PROTECTION	
		IP	CODE
			<b>G</b>
		IP00	

**PHOENIX CAM SWITCHES**

**PHOENIX CAM SWITCHES**

**BODIES CODIFICATION MAP**

BODY SWITCH TYPE			SCHEME TYPE			MOUNTING TYPE	
CODE	AC21A	TERMINAL PROT.	CODE	FUNCTION	SWITCH WAFER	CODE	MOUNTING
<b>PO12 0008 R</b>							
<b>ON-OFF SWITCHES</b>							
P012	12	IP20	0001	On-off switch 1 pole	1	R	REAR PANEL
PX12	12	IP10	0002	On-off switch 2 poles	1	R	REAR PANEL
P016	16	IP20	0003	On-off switch 3 poles	2	R	REAR PANEL
PX16	16	IP10	0004	On-off switch 4 poles	2	R	REAR PANEL
P020	20	IP20	0005	On-off switch 5 poles	3	B	BASE
PX20	20	IP10	0006	On-off switch 6 poles	3	B	BASE
C025	25	IP20	0007	On-off switch 3 poles with spring return to zero	2	B	BASE
CX25	25	IP10	0008	Changeover switch 1 pole	1	D	DIN
C032	32	IP20	0009	Changeover switch 2 poles	2	D	DIN
CX32	32	IP10	0010	Changeover switch 3 poles	3	D	DIN
C040	40	IP20	0011	Changeover switch 4 poles	4	D	DIN
CX40	40	IP10	0012	Reversing switch 3 poles	3	D	DIN
C063	63	IP00	0013	Reversing switch 3 poles with spring return to zero	3	D	DIN
C080	80	IP00	0014	Dahlander pole changing two speed switch	4	D	DIN
G125	125	IP00	0015	Star-delta starter switch	4	D	DIN
G200	200	IP00	0016	Reversing switch single phase with centrifugal cut-out	3	S	On request SPECIAL CAM SWITCHES according customers requirements or customizations.
			0017	Starter switch single phase with auxiliary phase	2	S	On request SPECIAL CAM SWITCHES according customers requirements or customizations.
			0018	Reversing-starter switch single phase with auxiliary phase	3	S	On request SPECIAL CAM SWITCHES according customers requirements or customizations.
			0031	Reversing-dahlander pole changing two speed switch	6	S	On request SPECIAL CAM SWITCHES according customers requirements or customizations.
<b>AMMETER AND VOLTMETER SWITCHES</b>							
			0019	Ammeter selector switch 1 pole for 3 current transformers	3	S	On request SPECIAL CAM SWITCHES according customers requirements or customizations.
			0020	Voltmeter selector switch phase-neutral	2	S	On request SPECIAL CAM SWITCHES according customers requirements or customizations.
			0021	Voltmeter selector switch phase-phase	2	S	On request SPECIAL CAM SWITCHES according customers requirements or customizations.
			0022	Voltmeter selector switch phase-phase for two circuits	4	S	On request SPECIAL CAM SWITCHES according customers requirements or customizations.
			0023	Voltmeter selector switch phase-phase and phase-neutral	3	S	On request SPECIAL CAM SWITCHES according customers requirements or customizations.
			0024	Voltmeter selector switch phase-phase and 1 phase-neutral	3	S	On request SPECIAL CAM SWITCHES according customers requirements or customizations.
<b>STEP SWITCHES</b>							
			0025	Step switch 1-2 positions without zero 1 pole	1	S	On request SPECIAL CAM SWITCHES according customers requirements or customizations.
			0026	Step switch 1-2 positions without zero 2 poles	2	S	On request SPECIAL CAM SWITCHES according customers requirements or customizations.
			0027	Step switch 1-2 positions without zero 3 poles	3	S	On request SPECIAL CAM SWITCHES according customers requirements or customizations.
			0028	Step switch 0-1-2 positions with zero 1 pole	1	S	On request SPECIAL CAM SWITCHES according customers requirements or customizations.
			0029	Step switch 0-1-2-3 positions with zero 1 pole	2	S	On request SPECIAL CAM SWITCHES according customers requirements or customizations.
			0030	Step switch 0-1-2-3-4 positions with zero 1 pole	2	S	On request SPECIAL CAM SWITCHES according customers requirements or customizations.
			0032	Step switch 0-1-2 positions with zero 2 poles	2	S	On request SPECIAL CAM SWITCHES according customers requirements or customizations.
			0033	Step switch 0-1-2 positions with zero 3 poles	3	S	On request SPECIAL CAM SWITCHES according customers requirements or customizations.
			0034	Step switch 0-1-2-3 positions with zero 2 poles	3	S	On request SPECIAL CAM SWITCHES according customers requirements or customizations.
			0035	Step switch 0-1-2-3 positions with zero 3 poles	5	S	On request SPECIAL CAM SWITCHES according customers requirements or customizations.
			0036	Step switch 0-1-2-3-4 positions with zero 2 poles	4	S	On request SPECIAL CAM SWITCHES according customers requirements or customizations.
			0037	Step switch 0-1-2-3-4 positions with zero 3 poles	6	S	On request SPECIAL CAM SWITCHES according customers requirements or customizations.
			0038	Step switch 1-2-3 positions without zero 1 pole	2	S	On request SPECIAL CAM SWITCHES according customers requirements or customizations.
			0039	Step switch 1-2-3 positions without zero 2 poles	3	S	On request SPECIAL CAM SWITCHES according customers requirements or customizations.
			0040	Step switch 1-2-3 positions without zero 3 poles	5	S	On request SPECIAL CAM SWITCHES according customers requirements or customizations.
			0041	Step switch 1-2-3-4 positions without zero 1 pole	2	S	On request SPECIAL CAM SWITCHES according customers requirements or customizations.
			0042	Step switch 1-2-3-4 positions without zero 2 poles	4	S	On request SPECIAL CAM SWITCHES according customers requirements or customizations.
			0043	Step switch 1-2-3-4 positions without zero 3 poles	6	S	On request SPECIAL CAM SWITCHES according customers requirements or customizations.

**ELECTRICAL SCHEMES**

ON-OFF SWITCHES 0-1																																																																																																																																		
0001	0002	0003	0004	0005	0006	0007																																																																																																																												
1 POLE	2 POLES	3 POLES	4 POLES	5 POLES	6 POLES	3 POLES WITH SPRING RETURN TO ZERO																																																																																																																												
1 2	1 3 2 4	1 3 5 2 4 6	1 3 5 7 2 4 6 8	1 3 5 7 9 2 4 6 8 10	1 3 5 7 9 11 2 4 6 8 10 12	1 3 5 2 4 6																																																																																																																												
<table border="1"><tr><td>1</td><td></td><td></td><td>X</td></tr><tr><td>WAF.</td><td>CONT.</td><td>0</td><td>1</td></tr></table>	1			X	WAF.	CONT.	0	1	<table border="1"><tr><td>1</td><td>3-4</td><td></td><td>X</td></tr><tr><td>1</td><td>1-2</td><td></td><td>X</td></tr><tr><td>WAF.</td><td>CONT.</td><td>0</td><td>1</td></tr></table>	1	3-4		X	1	1-2		X	WAF.	CONT.	0	1	<table border="1"><tr><td>2</td><td>5-6</td><td></td><td>X</td></tr><tr><td>1</td><td>3-4</td><td></td><td>X</td></tr><tr><td>1</td><td>1-2</td><td></td><td>X</td></tr><tr><td>WAF.</td><td>CONT.</td><td>0</td><td>1</td></tr></table>	2	5-6		X	1	3-4		X	1	1-2		X	WAF.	CONT.	0	1	<table border="1"><tr><td>2</td><td>7-8</td><td></td><td>X</td></tr><tr><td>2</td><td>5-6</td><td></td><td>X</td></tr><tr><td>1</td><td>3-4</td><td></td><td>X</td></tr><tr><td>1</td><td>1-2</td><td></td><td>X</td></tr><tr><td>WAF.</td><td>CONT.</td><td>0</td><td>1</td></tr></table>	2	7-8		X	2	5-6		X	1	3-4		X	1	1-2		X	WAF.	CONT.	0	1	<table border="1"><tr><td>3</td><td>9-10</td><td></td><td>X</td></tr><tr><td>2</td><td>7-8</td><td></td><td>X</td></tr><tr><td>2</td><td>5-6</td><td></td><td>X</td></tr><tr><td>1</td><td>3-4</td><td></td><td>X</td></tr><tr><td>1</td><td>1-2</td><td></td><td>X</td></tr><tr><td>WAF.</td><td>CONT.</td><td>0</td><td>1</td></tr></table>	3	9-10		X	2	7-8		X	2	5-6		X	1	3-4		X	1	1-2		X	WAF.	CONT.	0	1	<table border="1"><tr><td>3</td><td>11-12</td><td></td><td>X</td></tr><tr><td>3</td><td>9-10</td><td></td><td>X</td></tr><tr><td>2</td><td>7-8</td><td></td><td>X</td></tr><tr><td>2</td><td>5-6</td><td></td><td>X</td></tr><tr><td>1</td><td>3-4</td><td></td><td>X</td></tr><tr><td>1</td><td>1-2</td><td></td><td>X</td></tr><tr><td>WAF.</td><td>CONT.</td><td>0</td><td>1</td></tr></table>	3	11-12		X	3	9-10		X	2	7-8		X	2	5-6		X	1	3-4		X	1	1-2		X	WAF.	CONT.	0	1	<table border="1"><tr><td>2</td><td>5-6</td><td></td><td>X</td></tr><tr><td>1</td><td>3-4</td><td></td><td>X</td></tr><tr><td>1</td><td>1-2</td><td></td><td>X</td></tr><tr><td>WAF.</td><td>CONT.</td><td>0</td><td>1</td></tr></table>	2	5-6		X	1	3-4		X	1	1-2		X	WAF.	CONT.	0	1
1			X																																																																																																																															
WAF.	CONT.	0	1																																																																																																																															
1	3-4		X																																																																																																																															
1	1-2		X																																																																																																																															
WAF.	CONT.	0	1																																																																																																																															
2	5-6		X																																																																																																																															
1	3-4		X																																																																																																																															
1	1-2		X																																																																																																																															
WAF.	CONT.	0	1																																																																																																																															
2	7-8		X																																																																																																																															
2	5-6		X																																																																																																																															
1	3-4		X																																																																																																																															
1	1-2		X																																																																																																																															
WAF.	CONT.	0	1																																																																																																																															
3	9-10		X																																																																																																																															
2	7-8		X																																																																																																																															
2	5-6		X																																																																																																																															
1	3-4		X																																																																																																																															
1	1-2		X																																																																																																																															
WAF.	CONT.	0	1																																																																																																																															
3	11-12		X																																																																																																																															
3	9-10		X																																																																																																																															
2	7-8		X																																																																																																																															
2	5-6		X																																																																																																																															
1	3-4		X																																																																																																																															
1	1-2		X																																																																																																																															
WAF.	CONT.	0	1																																																																																																																															
2	5-6		X																																																																																																																															
1	3-4		X																																																																																																																															
1	1-2		X																																																																																																																															
WAF.	CONT.	0	1																																																																																																																															

CHANGEOVER SWITCHES 1-0-2																																																																																																			
0008	0009	0010	0011																																																																																																
1 POLE	2 POLES	3 POLES	4 POLES																																																																																																
1 0 2 60° G125 G200	1 0 2 60° G125 G200	1 0 2 60° G125 G200	1 0 2 60° G125 G200																																																																																																
2 4 1	2 4 6 8 1 5	2 4 6 8 10 12 1 5 9	2 4 6 8 10 12 14 16 1 5 9 13																																																																																																
<table border="1"><tr><td>1</td><td>3-4</td><td></td><td>X</td></tr><tr><td>1</td><td>1-2</td><td>X</td><td></td></tr><tr><td>WAF.</td><td>CONT.</td><td>1</td><td>0 2</td></tr></table>	1	3-4		X	1	1-2	X		WAF.	CONT.	1	0 2	<table border="1"><tr><td>2</td><td>7-8</td><td></td><td>X</td></tr><tr><td>2</td><td>5-6</td><td>X</td><td></td></tr><tr><td>1</td><td>3-4</td><td></td><td>X</td></tr><tr><td>1</td><td>1-2</td><td>X</td><td></td></tr><tr><td>WAF.</td><td>CONT.</td><td>1</td><td>0 2</td></tr></table>	2	7-8		X	2	5-6	X		1	3-4		X	1	1-2	X		WAF.	CONT.	1	0 2	<table border="1"><tr><td>3</td><td>11-12</td><td></td><td>X</td></tr><tr><td>3</td><td>9-10</td><td>X</td><td></td></tr><tr><td>2</td><td>7-8</td><td></td><td>X</td></tr><tr><td>2</td><td>5-6</td><td>X</td><td></td></tr><tr><td>1</td><td>3-4</td><td></td><td>X</td></tr><tr><td>1</td><td>1-2</td><td>X</td><td></td></tr><tr><td>WAF.</td><td>CONT.</td><td>1</td><td>0 2</td></tr></table>	3	11-12		X	3	9-10	X		2	7-8		X	2	5-6	X		1	3-4		X	1	1-2	X		WAF.	CONT.	1	0 2	<table border="1"><tr><td>4</td><td>15-16</td><td></td><td>X</td></tr><tr><td>4</td><td>13-14</td><td>X</td><td></td></tr><tr><td>3</td><td>11-12</td><td></td><td>X</td></tr><tr><td>3</td><td>9-10</td><td>X</td><td></td></tr><tr><td>2</td><td>7-8</td><td></td><td>X</td></tr><tr><td>2</td><td>5-6</td><td>X</td><td></td></tr><tr><td>1</td><td>3-4</td><td></td><td>X</td></tr><tr><td>1</td><td>1-2</td><td>X</td><td></td></tr><tr><td>WAF.</td><td>CONT.</td><td>1</td><td>0 2</td></tr></table>	4	15-16		X	4	13-14	X		3	11-12		X	3	9-10	X		2	7-8		X	2	5-6	X		1	3-4		X	1	1-2	X		WAF.	CONT.	1	0 2
1	3-4		X																																																																																																
1	1-2	X																																																																																																	
WAF.	CONT.	1	0 2																																																																																																
2	7-8		X																																																																																																
2	5-6	X																																																																																																	
1	3-4		X																																																																																																
1	1-2	X																																																																																																	
WAF.	CONT.	1	0 2																																																																																																
3	11-12		X																																																																																																
3	9-10	X																																																																																																	
2	7-8		X																																																																																																
2	5-6	X																																																																																																	
1	3-4		X																																																																																																
1	1-2	X																																																																																																	
WAF.	CONT.	1	0 2																																																																																																
4	15-16		X																																																																																																
4	13-14	X																																																																																																	
3	11-12		X																																																																																																
3	9-10	X																																																																																																	
2	7-8		X																																																																																																
2	5-6	X																																																																																																	
1	3-4		X																																																																																																
1	1-2	X																																																																																																	
WAF.	CONT.	1	0 2																																																																																																

**ELECTRICAL SCHEMES**

**ELECTRICAL SCHEMES**

**MOTOR SWITCHES**

**COMANDO MOTORI**

0012	0013	0014	0015																																																																																																																																					
REVERSING SWITCH 3 POLES	REVERSING SWITCH 3 POLES WITH SPRING RETURN TO ZERO	DAHLANDER POLE CHANGING TWO SPEED SWITCH	STAR-DELTA STARTER SWITCH																																																																																																																																					
 45°      60° G125    G200	 45°	 45°      60° G125    G200	 60°      60° G125    G200																																																																																																																																					
<table border="1"> <tr><td>3</td><td>9-10</td><td>X</td><td>X</td></tr> <tr><td>2</td><td>7-8</td><td>X</td><td></td></tr> <tr><td></td><td>5-6</td><td></td><td>X</td></tr> <tr><td>1</td><td>3-4</td><td></td><td>X</td></tr> <tr><td></td><td>1-2</td><td>X</td><td></td></tr> <tr><td>WAF</td><td>CONT.</td><td>1</td><td>0 2</td></tr> </table>	3	9-10	X	X	2	7-8	X			5-6		X	1	3-4		X		1-2	X		WAF	CONT.	1	0 2	<table border="1"> <tr><td>3</td><td>11-12</td><td>X</td><td></td></tr> <tr><td></td><td>9-10</td><td>X</td><td>X</td></tr> <tr><td>2</td><td>7-8</td><td>X</td><td></td></tr> <tr><td></td><td>5-6</td><td></td><td>X</td></tr> <tr><td>1</td><td>3-4</td><td></td><td>X</td></tr> <tr><td></td><td>1-2</td><td>X</td><td></td></tr> <tr><td>WAF</td><td>CONT.</td><td>1</td><td>0 2</td></tr> </table>	3	11-12	X			9-10	X	X	2	7-8	X			5-6		X	1	3-4		X		1-2	X		WAF	CONT.	1	0 2	<table border="1"> <tr><td>4</td><td>15-16</td><td></td><td>X</td></tr> <tr><td></td><td>13-14</td><td></td><td>X</td></tr> <tr><td>3</td><td>11-12</td><td>X</td><td></td></tr> <tr><td></td><td>9-10</td><td>X</td><td></td></tr> <tr><td>2</td><td>7-8</td><td></td><td>X</td></tr> <tr><td></td><td>5-6</td><td></td><td>X</td></tr> <tr><td>1</td><td>3-4</td><td>X</td><td></td></tr> <tr><td></td><td>1-2</td><td></td><td>X</td></tr> <tr><td>WAF</td><td>CONT.</td><td>1</td><td>0 2</td></tr> </table>	4	15-16		X		13-14		X	3	11-12	X			9-10	X		2	7-8		X		5-6		X	1	3-4	X			1-2		X	WAF	CONT.	1	0 2	<table border="1"> <tr><td>4</td><td>15-16</td><td></td><td></td><td>X</td></tr> <tr><td></td><td>13-14</td><td></td><td>X</td><td>X</td></tr> <tr><td>3</td><td>11-12</td><td></td><td>X</td><td>X</td></tr> <tr><td></td><td>9-10</td><td></td><td>X</td><td>X</td></tr> <tr><td>2</td><td>7-8</td><td></td><td>X</td><td></td></tr> <tr><td></td><td>5-6</td><td></td><td></td><td>X</td></tr> <tr><td>1</td><td>3-4</td><td></td><td></td><td>X</td></tr> <tr><td></td><td>1-2</td><td></td><td>X</td><td>X</td></tr> <tr><td>WAF</td><td>CONT.</td><td>0</td><td>Y</td><td>Δ</td></tr> </table>	4	15-16			X		13-14		X	X	3	11-12		X	X		9-10		X	X	2	7-8		X			5-6			X	1	3-4			X		1-2		X	X	WAF	CONT.	0	Y	Δ
3	9-10	X	X																																																																																																																																					
2	7-8	X																																																																																																																																						
	5-6		X																																																																																																																																					
1	3-4		X																																																																																																																																					
	1-2	X																																																																																																																																						
WAF	CONT.	1	0 2																																																																																																																																					
3	11-12	X																																																																																																																																						
	9-10	X	X																																																																																																																																					
2	7-8	X																																																																																																																																						
	5-6		X																																																																																																																																					
1	3-4		X																																																																																																																																					
	1-2	X																																																																																																																																						
WAF	CONT.	1	0 2																																																																																																																																					
4	15-16		X																																																																																																																																					
	13-14		X																																																																																																																																					
3	11-12	X																																																																																																																																						
	9-10	X																																																																																																																																						
2	7-8		X																																																																																																																																					
	5-6		X																																																																																																																																					
1	3-4	X																																																																																																																																						
	1-2		X																																																																																																																																					
WAF	CONT.	1	0 2																																																																																																																																					
4	15-16			X																																																																																																																																				
	13-14		X	X																																																																																																																																				
3	11-12		X	X																																																																																																																																				
	9-10		X	X																																																																																																																																				
2	7-8		X																																																																																																																																					
	5-6			X																																																																																																																																				
1	3-4			X																																																																																																																																				
	1-2		X	X																																																																																																																																				
WAF	CONT.	0	Y	Δ																																																																																																																																				

0016	0031	0017	0018																																																																																																																																																												
REVERSING SWITCH SINGLE PHASE WITH CENTRIFUGAL CUT-OUT	REVERSING-DAHLANDER POLE CHANGING TWO SPEED SWITCH	STARTER SWITCH SINGLE PHASE WITH AUXILIARY PHASE	REVERSING-STARTER SWITCH SINGLE PHASE WITH AUXILIARY PHASE																																																																																																																																																												
 45°	 45°	 45°	 45°																																																																																																																																																												
<table border="1"> <tr><td>3</td><td>11-12</td><td>X</td><td></td></tr> <tr><td></td><td>9-10</td><td></td><td>X</td></tr> <tr><td>2</td><td>7-8</td><td></td><td>X</td></tr> <tr><td></td><td>5-6</td><td>X</td><td></td></tr> <tr><td>1</td><td>3-4</td><td>X</td><td>X</td></tr> <tr><td></td><td>1-2</td><td>X</td><td>X</td></tr> <tr><td>WAF</td><td>CONT.</td><td>1</td><td>0 2</td></tr> </table>	3	11-12	X			9-10		X	2	7-8		X		5-6	X		1	3-4	X	X		1-2	X	X	WAF	CONT.	1	0 2	<table border="1"> <tr><td>6</td><td>23-24</td><td>X</td><td></td><td></td><td>X</td></tr> <tr><td></td><td>21-22</td><td></td><td>X</td><td>X</td><td></td></tr> <tr><td>5</td><td>19-20</td><td>X</td><td></td><td></td><td>X</td></tr> <tr><td></td><td>17-18</td><td>X</td><td></td><td></td><td>X</td></tr> <tr><td>4</td><td>15-16</td><td></td><td>X</td><td>X</td><td></td></tr> <tr><td></td><td>13-14</td><td></td><td>X</td><td>X</td><td></td></tr> <tr><td>3</td><td>11-12</td><td>X</td><td></td><td></td><td>X</td></tr> <tr><td></td><td>9-10</td><td>X</td><td></td><td></td><td>X</td></tr> <tr><td>2</td><td>7-8</td><td></td><td></td><td>X</td><td>X</td></tr> <tr><td></td><td>5-6</td><td>X</td><td>X</td><td></td><td></td></tr> <tr><td>1</td><td>3-4</td><td>X</td><td>X</td><td></td><td></td></tr> <tr><td></td><td>1-2</td><td></td><td></td><td>X</td><td>X</td></tr> <tr><td>WAF</td><td>CONT.</td><td>2</td><td>0 1 0</td><td>1 0 2</td></tr> </table>	6	23-24	X			X		21-22		X	X		5	19-20	X			X		17-18	X			X	4	15-16		X	X			13-14		X	X		3	11-12	X			X		9-10	X			X	2	7-8			X	X		5-6	X	X			1	3-4	X	X				1-2			X	X	WAF	CONT.	2	0 1 0	1 0 2	<table border="1"> <tr><td>2</td><td>7-8</td><td>X</td><td>X</td></tr> <tr><td></td><td>5-6</td><td>X</td><td>X</td></tr> <tr><td>1</td><td>1-2</td><td></td><td>X</td></tr> <tr><td>WAF</td><td>CONT.</td><td>0</td><td>1 AVV.</td></tr> </table>	2	7-8	X	X		5-6	X	X	1	1-2		X	WAF	CONT.	0	1 AVV.	<table border="1"> <tr><td>3</td><td>11-12</td><td>X</td><td>X</td><td>X</td></tr> <tr><td></td><td>9-10</td><td>X</td><td>X</td><td>X</td></tr> <tr><td>2</td><td>7-8</td><td></td><td></td><td>X</td></tr> <tr><td></td><td>5-6</td><td>X</td><td></td><td></td></tr> <tr><td>1</td><td>3-4</td><td>X</td><td>X</td><td></td></tr> <tr><td></td><td>1-2</td><td></td><td></td><td>X</td></tr> <tr><td>WAF</td><td>CONT.</td><td>AVV.</td><td>1</td><td>0 2 AVV.</td></tr> </table>	3	11-12	X	X	X		9-10	X	X	X	2	7-8			X		5-6	X			1	3-4	X	X			1-2			X	WAF	CONT.	AVV.	1	0 2 AVV.
3	11-12	X																																																																																																																																																													
	9-10		X																																																																																																																																																												
2	7-8		X																																																																																																																																																												
	5-6	X																																																																																																																																																													
1	3-4	X	X																																																																																																																																																												
	1-2	X	X																																																																																																																																																												
WAF	CONT.	1	0 2																																																																																																																																																												
6	23-24	X			X																																																																																																																																																										
	21-22		X	X																																																																																																																																																											
5	19-20	X			X																																																																																																																																																										
	17-18	X			X																																																																																																																																																										
4	15-16		X	X																																																																																																																																																											
	13-14		X	X																																																																																																																																																											
3	11-12	X			X																																																																																																																																																										
	9-10	X			X																																																																																																																																																										
2	7-8			X	X																																																																																																																																																										
	5-6	X	X																																																																																																																																																												
1	3-4	X	X																																																																																																																																																												
	1-2			X	X																																																																																																																																																										
WAF	CONT.	2	0 1 0	1 0 2																																																																																																																																																											
2	7-8	X	X																																																																																																																																																												
	5-6	X	X																																																																																																																																																												
1	1-2		X																																																																																																																																																												
WAF	CONT.	0	1 AVV.																																																																																																																																																												
3	11-12	X	X	X																																																																																																																																																											
	9-10	X	X	X																																																																																																																																																											
2	7-8			X																																																																																																																																																											
	5-6	X																																																																																																																																																													
1	3-4	X	X																																																																																																																																																												
	1-2			X																																																																																																																																																											
WAF	CONT.	AVV.	1	0 2 AVV.																																																																																																																																																											

**ELECTRICAL SCHEMES**

**ELECTRICAL SCHEMES**

**AMMETER AND VOLTMETER SWITCHES**

**STEP SWITCHES**

0019	0020	0021
------	------	------

AMMETER SELECTOR SWITCH 1 POLE FOR 3 CURRENT TRANSFORMERS	VOLTMETER SELECTOR SWITCH PHASE-NEUTRAL	VOLTMETER SELECTOR SWITCH PHASE-PHASE
---	---	---------------------------------------

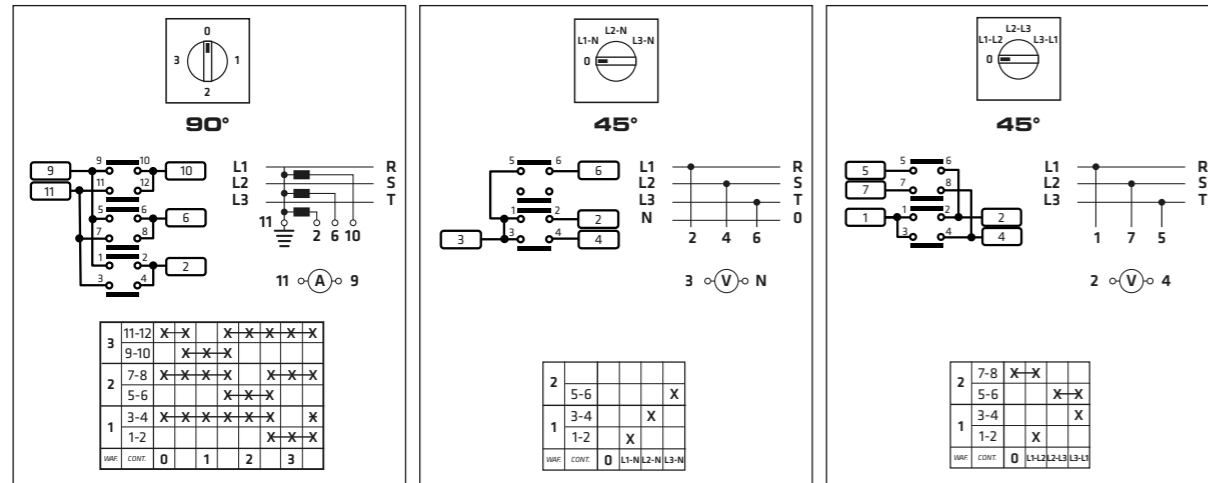

0022	0023	0024
------	------	------

VOLTMETER SELECTOR SWITCH PHASE-PHASE FOR TWO CIRCUITS	VOLTMETER SELECTOR SWITCH PHASE-PHASE AND PHASE-NEUTRAL	VOLTMETER SELECTOR SWITCH PHASE-PHASE AND 1 PHASE-NEUTRAL
--	---	---

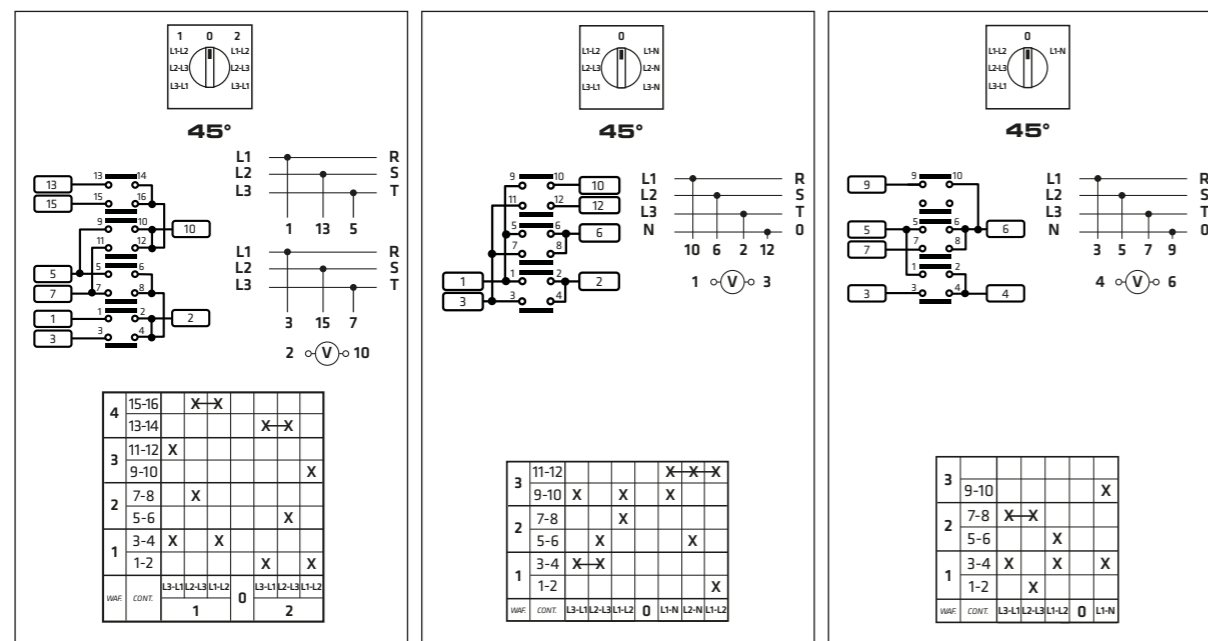

0025	0026	0027
------	------	------

STEP SWITCH 1-2 POSITIONS WITHOUT ZERO 1 POLE	STEP SWITCH 1-2 POSITIONS WITHOUT ZERO 2 POLES	STEP SWITCH 1-2 POSITIONS WITHOUT ZERO 3 POLES
---	--	--

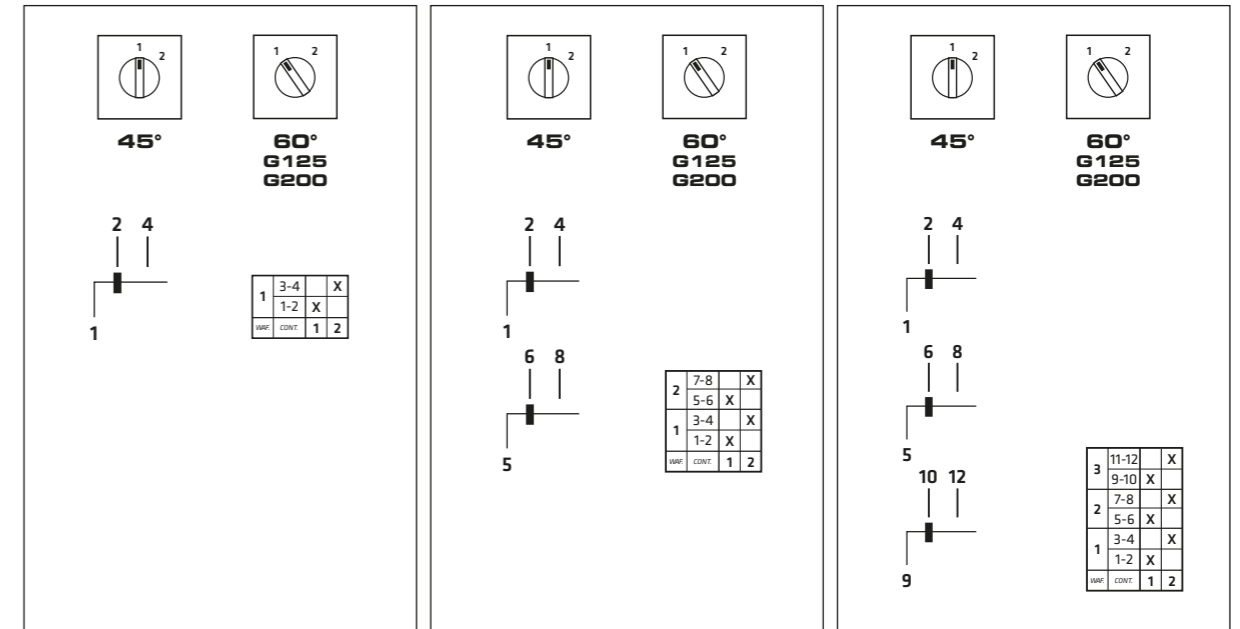

0038	0039	0040
------	------	------

STEP SWITCH 1-2-3 POSITIONS WITHOUT ZERO 1 POLE	STEP SWITCH 1-2-3 POSITIONS WITHOUT ZERO 2 POLES	STEP SWITCH 1-2-3 POSITIONS WITHOUT ZERO 3 POLES
---	--	--

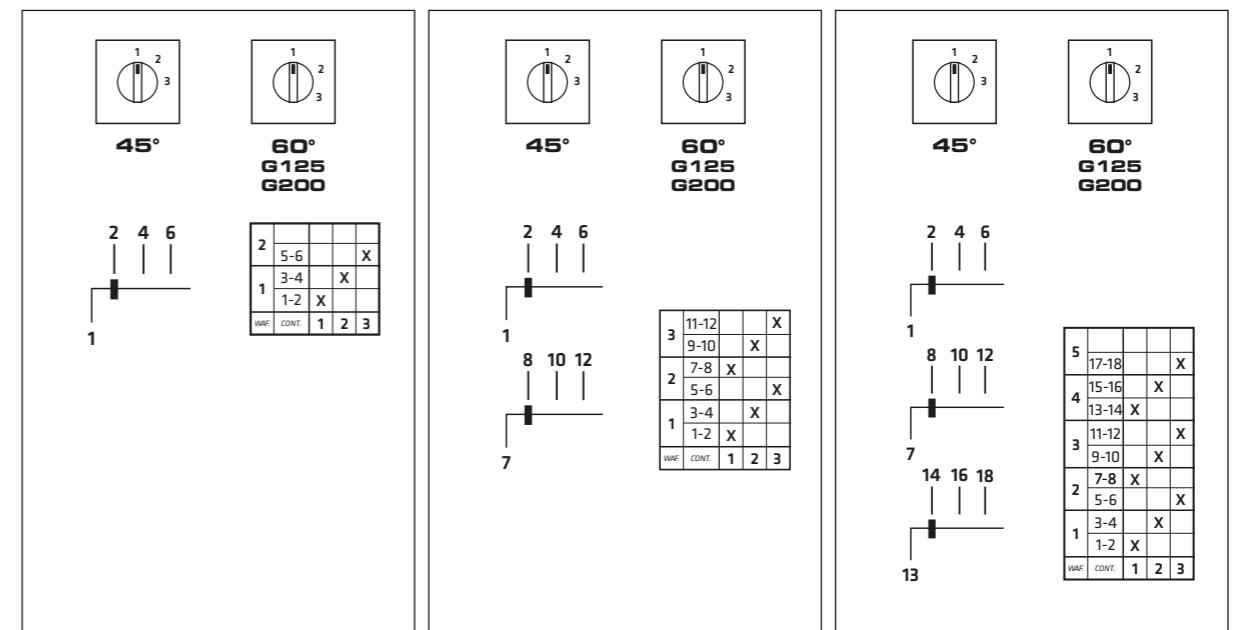

**ELECTRICAL SCHEMES**

**ELECTRICAL SCHEMES**

**STEP SWITCHES**

0041	0042	0043																																																																																																																																										
STEP SWITCH 1-2-3-4 POSITIONS WITHOUT ZERO 1 POLE	STEP SWITCH 1-2-3-4 POSITIONS WITHOUT ZERO 2 POLES	STEP SWITCH 1-2-3-4 POSITIONS WITHOUT ZERO 3 POLES																																																																																																																																										
 <b>45°</b> <b>90°</b> <b>G125</b> <b>G200</b>	 <b>45°</b> <b>90°</b> <b>G125</b> <b>G200</b>	 <b>45°</b> <b>90°</b> <b>G125</b> <b>G200</b>																																																																																																																																										
 <table border="1" style="font-size: small; margin-left: auto; margin-right: auto;"> <tr><td>2</td><td>7-8</td><td></td><td></td><td>X</td></tr> <tr><td>3</td><td>5-6</td><td></td><td></td><td></td></tr> <tr><td>4</td><td>3-4</td><td>X</td><td></td><td></td></tr> <tr><td>1</td><td>1-2</td><td>X</td><td></td><td></td></tr> <tr><td>VARF</td><td>CONF.</td><td>1</td><td>2</td><td>3</td><td>4</td></tr> </table>	2	7-8			X	3	5-6				4	3-4	X			1	1-2	X			VARF	CONF.	1	2	3	4	 <table border="1" style="font-size: small; margin-left: auto; margin-right: auto;"> <tr><td>4</td><td>15-16</td><td></td><td></td><td>X</td></tr> <tr><td>3</td><td>13-14</td><td></td><td></td><td></td></tr> <tr><td>2</td><td>11-12</td><td>X</td><td></td><td></td></tr> <tr><td>1</td><td>9-10</td><td></td><td></td><td>X</td></tr> <tr><td></td><td>7-8</td><td></td><td></td><td></td></tr> <tr><td></td><td>5-6</td><td></td><td></td><td>X</td></tr> <tr><td></td><td>3-4</td><td>X</td><td></td><td></td></tr> <tr><td></td><td>1-2</td><td>X</td><td></td><td></td></tr> <tr><td>VARF</td><td>CONF.</td><td>1</td><td>2</td><td>3</td><td>4</td></tr> </table>	4	15-16			X	3	13-14				2	11-12	X			1	9-10			X		7-8					5-6			X		3-4	X				1-2	X			VARF	CONF.	1	2	3	4	 <table border="1" style="font-size: small; margin-left: auto; margin-right: auto;"> <tr><td>6</td><td>23-24</td><td></td><td></td><td>X</td></tr> <tr><td>5</td><td>21-22</td><td></td><td></td><td></td></tr> <tr><td>4</td><td>19-20</td><td>X</td><td></td><td></td></tr> <tr><td>3</td><td>17-18</td><td></td><td></td><td>X</td></tr> <tr><td>2</td><td>15-16</td><td></td><td></td><td></td></tr> <tr><td>1</td><td>13-14</td><td></td><td></td><td>X</td></tr> <tr><td></td><td>11-12</td><td>X</td><td></td><td></td></tr> <tr><td></td><td>9-10</td><td></td><td></td><td>X</td></tr> <tr><td></td><td>7-8</td><td></td><td></td><td></td></tr> <tr><td></td><td>5-6</td><td></td><td></td><td>X</td></tr> <tr><td></td><td>3-4</td><td>X</td><td></td><td></td></tr> <tr><td></td><td>1-2</td><td>X</td><td></td><td></td></tr> <tr><td>VARF</td><td>CONF.</td><td>1</td><td>2</td><td>3</td><td>4</td></tr> </table>	6	23-24			X	5	21-22				4	19-20	X			3	17-18			X	2	15-16				1	13-14			X		11-12	X				9-10			X		7-8					5-6			X		3-4	X				1-2	X			VARF	CONF.	1	2	3	4
2	7-8			X																																																																																																																																								
3	5-6																																																																																																																																											
4	3-4	X																																																																																																																																										
1	1-2	X																																																																																																																																										
VARF	CONF.	1	2	3	4																																																																																																																																							
4	15-16			X																																																																																																																																								
3	13-14																																																																																																																																											
2	11-12	X																																																																																																																																										
1	9-10			X																																																																																																																																								
	7-8																																																																																																																																											
	5-6			X																																																																																																																																								
	3-4	X																																																																																																																																										
	1-2	X																																																																																																																																										
VARF	CONF.	1	2	3	4																																																																																																																																							
6	23-24			X																																																																																																																																								
5	21-22																																																																																																																																											
4	19-20	X																																																																																																																																										
3	17-18			X																																																																																																																																								
2	15-16																																																																																																																																											
1	13-14			X																																																																																																																																								
	11-12	X																																																																																																																																										
	9-10			X																																																																																																																																								
	7-8																																																																																																																																											
	5-6			X																																																																																																																																								
	3-4	X																																																																																																																																										
	1-2	X																																																																																																																																										
VARF	CONF.	1	2	3	4																																																																																																																																							

**STEP SWITCHES**

0029	0034	0035																																																																																																																	
STEP SWITCH 0-1-2-3 POSITIONS WITH ZERO 1 POLE	STEP SWITCH 0-1-2-3 POSITIONS WITH ZERO 2 POLES	STEP SWITCH 0-1-2-3 POSITIONS WITH ZERO 3 POLES																																																																																																																	
 <b>45°</b> <b>90°</b> <b>G125</b> <b>G200</b>	 <b>45°</b> <b>90°</b> <b>G125</b> <b>G200</b>	 <b>45°</b> <b>90°</b> <b>G125</b> <b>G200</b>																																																																																																																	
 <table border="1" style="font-size: small; margin-left: auto; margin-right: auto;"> <tr><td>2</td><td>7-8</td><td></td><td></td><td>X</td></tr> <tr><td>3</td><td>5-6</td><td>X</td><td></td><td></td></tr> <tr><td>1</td><td>1-2</td><td></td><td>X</td><td></td></tr> <tr><td>VARF</td><td>CONF.</td><td>0</td><td>1</td><td>2</td><td>3</td></tr> </table>	2	7-8			X	3	5-6	X			1	1-2		X		VARF	CONF.	0	1	2	3	 <table border="1" style="font-size: small; margin-left: auto; margin-right: auto;"> <tr><td>3</td><td>11-12</td><td></td><td></td><td>X</td></tr> <tr><td>2</td><td>9-10</td><td></td><td>X</td><td></td></tr> <tr><td>1</td><td>7-8</td><td></td><td>X</td><td></td></tr> <tr><td></td><td>5-6</td><td></td><td>X</td><td></td></tr> <tr><td></td><td>3-4</td><td>X</td><td></td><td></td></tr> <tr><td></td><td>1-2</td><td>X</td><td></td><td></td></tr> <tr><td>VARF</td><td>CONF.</td><td>0</td><td>1</td><td>2</td><td>3</td></tr> </table>	3	11-12			X	2	9-10		X		1	7-8		X			5-6		X			3-4	X				1-2	X			VARF	CONF.	0	1	2	3	 <table border="1" style="font-size: small; margin-left: auto; margin-right: auto;"> <tr><td>5</td><td>19-20</td><td></td><td></td><td>X</td></tr> <tr><td>4</td><td>17-18</td><td></td><td></td><td></td></tr> <tr><td>3</td><td>15-16</td><td></td><td>X</td><td></td></tr> <tr><td>2</td><td>13-14</td><td>X</td><td></td><td></td></tr> <tr><td>1</td><td>11-12</td><td></td><td>X</td><td></td></tr> <tr><td></td><td>9-10</td><td></td><td>X</td><td></td></tr> <tr><td></td><td>7-8</td><td></td><td>X</td><td></td></tr> <tr><td></td><td>5-6</td><td></td><td>X</td><td></td></tr> <tr><td></td><td>3-4</td><td>X</td><td></td><td></td></tr> <tr><td></td><td>1-2</td><td>X</td><td></td><td></td></tr> <tr><td>VARF</td><td>CONF.</td><td>0</td><td>1</td><td>2</td><td>3</td></tr> </table>	5	19-20			X	4	17-18				3	15-16		X		2	13-14	X			1	11-12		X			9-10		X			7-8		X			5-6		X			3-4	X				1-2	X			VARF	CONF.	0	1	2	3
2	7-8			X																																																																																																															
3	5-6	X																																																																																																																	
1	1-2		X																																																																																																																
VARF	CONF.	0	1	2	3																																																																																																														
3	11-12			X																																																																																																															
2	9-10		X																																																																																																																
1	7-8		X																																																																																																																
	5-6		X																																																																																																																
	3-4	X																																																																																																																	
	1-2	X																																																																																																																	
VARF	CONF.	0	1	2	3																																																																																																														
5	19-20			X																																																																																																															
4	17-18																																																																																																																		
3	15-16		X																																																																																																																
2	13-14	X																																																																																																																	
1	11-12		X																																																																																																																
	9-10		X																																																																																																																
	7-8		X																																																																																																																
	5-6		X																																																																																																																
	3-4	X																																																																																																																	
	1-2	X																																																																																																																	
VARF	CONF.	0	1	2	3																																																																																																														

**STEP SWITCHES**

0028	0032	0033																																																															
STEP SWITCH 0-1-2 POSITIONS WITH ZERO 1 POLE	STEP SWITCH 0-1-2 POSITIONS WITH ZERO 2 POLES	STEP SWITCH 0-1-2 POSITIONS WITH ZERO 3 POLES																																																															
 <b>45°</b> <b>60°</b> <b>G125</b> <b>G200</b>	 <b>45°</b> <b>60°</b> <b>G125</b> <b>G200</b>	 <b>45°</b> <b>60°</b> <b>G125</b> <b>G200</b>																																																															
 <table border="1" style="font-size: small; margin-left: auto; margin-right: auto;"> <tr><td>1</td><td>3-4</td><td></td><td>X</td></tr> <tr><td></td><td>1-2</td><td></td><td>X</td></tr> <tr><td>VARF</td><td>CONF.</td><td>0</td><td>1</td><td>2</td></tr> </table>	1	3-4		X		1-2		X	VARF	CONF.	0	1	2	 <table border="1" style="font-size: small; margin-left: auto; margin-right: auto;"> <tr><td>2</td><td>7-8</td><td></td><td>X</td></tr> <tr><td>1</td><td>5-6</td><td></td><td>X</td></tr> <tr><td></td><td>3-4</td><td>X</td><td></td></tr> <tr><td></td><td>1-2</td><td>X</td><td></td></tr> <tr><td>VARF</td><td>CONF.</td><td>0</td><td>1</td><td>2</td></tr> </table>	2	7-8		X	1	5-6		X		3-4	X			1-2	X		VARF	CONF.	0	1	2	 <table border="1" style="font-size: small; margin-left: auto; margin-right: auto;"> <tr><td>3</td><td>11-12</td><td></td><td>X</td></tr> <tr><td>2</td><td>9-10</td><td></td><td>X</td></tr> <tr><td>1</td><td>7-8</td><td></td><td>X</td></tr> <tr><td></td><td>5-6</td><td></td><td>X</td></tr> <tr><td></td><td>3-4</td><td>X</td><td></td></tr> <tr><td></td><td>1-2</td><td>X</td><td></td></tr> <tr><td>VARF</td><td>CONF.</td><td>0</td><td>1</td><td>2</td></tr> </table>	3	11-12		X	2	9-10		X	1	7-8		X		5-6		X		3-4	X			1-2	X		VARF	CONF.	0	1	2
1	3-4		X																																																														
	1-2		X																																																														
VARF	CONF.	0	1	2																																																													
2	7-8		X																																																														
1	5-6		X																																																														
	3-4	X																																																															
	1-2	X																																																															
VARF	CONF.	0	1	2																																																													
3	11-12		X																																																														
2	9-10		X																																																														
1	7-8		X																																																														
	5-6		X																																																														
	3-4	X																																																															
	1-2	X																																																															
VARF	CONF.	0	1	2																																																													

**STEP SWITCHES**

0030	0036	0037																																																																																																																																													
STEP SWITCH 0-1-2-3-4 POSITIONS WITH ZERO 1 POLE	STEP SWITCH 0-1-2-3-4 POSITIONS WITH ZERO 2 POLES	STEP SWITCH 0-1-2-3-4 POSITIONS WITH ZERO 3 POLES																																																																																																																																													
 <b>45°</b> <b>60°</b> <b>G125</b> <b>G200</b>	 <b>45°</b> <b>60°</b> <b>G125</b> <b>G200</b>	 <b>45°</b> <b>60°</b> <b>G125</b> <b>G200</b>																																																																																																																																													
 <table border="1" style="font-size: small; margin-left: auto; margin-right: auto;"> <tr><td>2</td><td>7-8</td><td></td><td></td><td>X</td></tr> <tr><td>3</td><td>5-6</td><td>X</td><td></td><td></td></tr> <tr><td>1</td><td>3-4</td><td></td><td>X</td><td></td></tr> <tr><td></td><td>1-2</td><td></td><td>X</td><td></td></tr> <tr><td>VARF</td><td>CONF.</td><td>0</td><td>1</td><td>2</td><td>3</td><td>4</td></tr> </table>	2	7-8			X	3	5-6	X			1	3-4		X			1-2		X		VARF	CONF.	0	1	2	3	4	 <table border="1" style="font-size: small; margin-left: auto; margin-right: auto;"> <tr><td>4</td><td>15-16</td><td></td><td></td><td>X</td></tr> <tr><td>3</td><td>13-14</td><td></td><td>X</td><td></td></tr> <tr><td>2</td><td>11-12</td><td></td><td>X</td><td></td></tr> <tr><td>1</td><td>9-10</td><td></td><td>X</td><td></td></tr> <tr><td></td><td>7-8</td><td></td><td>X</td><td></td></tr> <tr><td></td><td>5-6</td><td>X</td><td></td><td></td></tr> <tr><td></td><td>3-4</td><td>X</td><td></td><td></td></tr> <tr><td></td><td>1-2</td><td>X</td><td></td><td></td></tr> <tr><td>VARF</td><td>CONF.</td><td>0</td><td>1</td><td>2</td><td>3</td><td>4</td></tr> </table>	4	15-16			X	3	13-14		X		2	11-12		X		1	9-10		X			7-8		X			5-6	X				3-4	X				1-2	X			VARF	CONF.	0	1	2	3	4	 <table border="1" style="font-size: small; margin-left: auto; margin-right: auto;"> <tr><td>6</td><td>23-24</td><td></td><td></td><td>X</td></tr> <tr><td>5</td><td>21-22</td><td></td><td>X</td><td></td></tr> <tr><td>4</td><td>19-20</td><td></td><td>X</td><td></td></tr> <tr><td>3</td><td>17-18</td><td></td><td>X</td><td></td></tr> <tr><td>2</td><td>15-16</td><td></td><td>X</td><td></td></tr> <tr><td>1</td><td>13-14</td><td>X</td><td></td><td></td></tr> <tr><td></td><td>11-12</td><td></td><td>X</td><td></td></tr> <tr><td></td><td>9-10</td><td></td><td>X</td><td></td></tr> <tr><td></td><td>7-8</td><td></td><td>X</td><td></td></tr> <tr><td></td><td>5-6</td><td>X</td><td></td><td></td></tr> <tr><td></td><td>3-4</td><td>X</td><td></td><td></td></tr> <tr><td></td><td>1-2</td><td>X</td><td></td><td></td></tr> <tr><td>VARF</td><td>CONF.</td><td>0</td><td>1</td><td>2</td><td>3</td><td>4</td></tr> </table>	6	23-24			X	5	21-22		X		4	19-20		X		3	17-18		X		2	15-16		X		1	13-14	X				11-12		X			9-10		X			7-8		X			5-6	X				3-4	X				1-2	X			VARF	CONF.	0	1	2	3	4
2	7-8			X																																																																																																																																											
3	5-6	X																																																																																																																																													
1	3-4		X																																																																																																																																												
	1-2		X																																																																																																																																												
VARF	CONF.	0	1	2	3	4																																																																																																																																									
4	15-16			X																																																																																																																																											
3	13-14		X																																																																																																																																												
2	11-12		X																																																																																																																																												
1	9-10		X																																																																																																																																												
	7-8		X																																																																																																																																												
	5-6	X																																																																																																																																													
	3-4	X																																																																																																																																													
	1-2	X																																																																																																																																													
VARF	CONF.	0	1	2	3	4																																																																																																																																									
6	23-24			X																																																																																																																																											
5	21-22		X																																																																																																																																												
4	19-20		X																																																																																																																																												
3	17-18		X																																																																																																																																												
2	15-16		X																																																																																																																																												
1	13-14	X																																																																																																																																													
	11-12		X																																																																																																																																												
	9-10		X																																																																																																																																												
	7-8		X																																																																																																																																												
	5-6	X																																																																																																																																													
	3-4	X																																																																																																																																													
	1-2	X																																																																																																																																													
VARF	CONF.	0	1	2	3	4																																																																																																																																									

**ACTUATORS RANGE OVERVIEW**

<b>AC21A</b>	<ul style="list-style-type: none"> <li>Grey plate</li> <li>Black knob</li> </ul>	<ul style="list-style-type: none"> <li>Yellow plate</li> <li>Red knob</li> </ul>	<ul style="list-style-type: none"> <li>Grey plate</li> <li>Black knob</li> <li>Padlockable (Max 1)</li> <li>Padlockable in 0</li> </ul>	<ul style="list-style-type: none"> <li>Yellow plate</li> <li>Red knob</li> <li>Padlockable (Max 1)</li> <li>Padlockable in 0</li> </ul>	<ul style="list-style-type: none"> <li>Grey plate</li> <li>Black knob</li> <li>Padlockable (Max 3)</li> <li>Padlockable in 0</li> </ul>	<ul style="list-style-type: none"> <li>Yellow plate</li> <li>Red knob</li> <li>Padlockable (Max 3)</li> <li>Padlockable in 0</li> </ul>	<ul style="list-style-type: none"> <li>Grey plate</li> <li>Key operated</li> </ul>	<ul style="list-style-type: none"> <li>Without plate</li> <li>Knob operated</li> </ul>	<ul style="list-style-type: none"> <li>Without plate</li> <li>Key operated</li> </ul>	<ul style="list-style-type: none"> <li>DIN 45x52,3</li> <li>46 mm standard boxes</li> </ul>						
<b>12A 16A 20A</b>																
<b>25A 32A 40A</b>																
<b>63A 80A</b>																
<b>125A</b>																
<b>200A</b>																



**ACTUATORS CODIFICATION MAP**

**001 / 0001-1**

**FAMILY TYPE**

ACTUATOR	LINE	□	MOUNTING	CODE	PROT. CLASS.
	12-16-20	48	R screw	001/...	IP65
	12-16-20	48	R ø22	056X/...	IP65
	25-32-40	64	R screw	007/...	IP65
	63-80	88	R screw	201/...	IP65
	125	88	R screw	441/...	IP65
	200	88	R screw	461/...	IP65
	12-16-20	48	B screw	020/...	IP65
	25-32-40	64	B screw	021/...	IP65
	12...40	48	B ø22	095/...	IP65
	63-80	88	B screw	220/...	IP65

Grey plate Black knob

	12-16-20	48	R screw	002/...	IP65
	12-16-20	48	R ø22	058X/...	IP65
	25-32-40	64	R screw	008/...	IP65
	12-16-20	48	B screw	030/...	IP65
	12...40	48	B ø22	070/...	IP65

Yellow plate Red knob

	12...40	48	R screw	003/...	IP65 4-4X
	12-16-20	48	R ø22	059X/...	IP65
	12...40	48	B screw	005/...	IP65 4-4X
	12...40	48	B ø22	077/...	IP65 4-4X

Grey plate Black knob Padlockable (Max 1)  
Padlockable in 0

	12...40	48	R screw	004/...	IP65 4-4X
	12-16-20	48	R ø22	060X/...	IP65
	12...40	48	B screw	006/...	IP65 4-4X
	12...40	48	B ø22	069/...	IP65 4-4X

Yellow plate Red knob Padlockable (Max 1)  
Padlockable in 0

ACTUATOR	LINE	□	MOUNTING	CODE	PROT. CLASS.
	12...40	67	R screw	009/...	IP65 4-4X
	12-16-20	67	R ø22	061X/...	IP65
	63-80	92	R screw	209/...	IP65
	125-200	95	R screw	449/...	IP65
	12...40	67	B screw	011/...	IP65 4-4X
	12...40	67	B ø22	063/...	IP65 4-4X
	63-80	92	B screw	211/...	IP65
	125-200	95	B screw	451/...	IP65

Grey plate Black knob Padlockable (Max 3)  
Padlockable in 0

	12...40	67	R screw	010/...	IP65 4-4X
	12-16-20	67	R ø22	062X/...	IP65
	63-80	92	R screw	210/...	IP65
	125-200	95	R screw	450/...	IP65
	12...40	67	B screw	012/...	IP65 4-4X
	12...40	67	B ø22	064/...	IP65 4-4X
	63-80	92	B screw	212/...	IP65
	125-200	95	B screw	452/...	IP65

Yellow plate Red knob Padlockable (Max 3)  
Padlockable in 0

	12-16-20	48	R ø22	057X/...	IP65
---	----------	----	-------	----------	------

Grey plate Key operated  
Key removable at "0" position

	12-16-20	-	R ø22	028X	IP65
---	----------	---	-------	------	------

Without plate Knob operated

















	12-16-20	-	R ø22	029X	IP65
---	----------	---	-------	------	------

Without plate Key operated  
Key removable at 0° and 180° position

	12-16-20	45x52	D screw	027/...	-
---	----------	-------	---------	---------	---

Grey plate Black knob  
46 mm standard boxes

**SCHEME/INSCRIPTION TYPE - version or key extraction position**

ON-OFF SWITCHES 0-1	CHANGEOVER SWITCHES 1-0-2 MOTOR SWITCHES	STEP SWITCHES	AMMETER SWITCHES	VOLTMETER SWITCHES
 90°  90°  45°	 45°  45°  45°  60° <b>G125</b> <b>G200</b>	 45°  45°  60° <b>G125</b> <b>G200</b>  60° <b>G125</b> <b>G200</b>	 90° 001/0019 027/0019 056X/0019	 45° 001/0020 027/0020 056X/0020  45° 001/0021 027/0021 056X/0021  45° 001/0022 056X/0022  45° 001/0023 027/0023 056X/0023  45° 001/0024 027/0024 056X/0024
001/0001 002/0001 003/0001 004/0001 005/0001 006/0001 007/0001 008/0001 009/0001 010/0001 011/0001 012/0001 020/0001 021/0001 030/0001 056X/0001 057X/0001 058X/0001 059X/0001 060X/0001 061X/0001 062X/0001 063/0001 064/0001 069/0001 070/0001 077/0001 095/0001 201/0001 210/0001 211/0001 212/0001 220/0001 441/0001 449/0001 450/0001 451/0001 452/0001 461/0001	001/0001-1 002/0001-1 003/0001-1 004/0001-1 007/0007 008/0001-1 010/0007 010/0001-1 011/0001-A 012/0001-2 027/0001 056X/0001-1 057X/0001-1 058X/0001-1 059X/0001-1 060X/0001-1 061X/0001-1 062X/0001-1 063/0001-1 064/0001-1 201/0001-1 209/0001-1 210/0001-1 211/0001-1 212/0001-1	001/0007 002/0007 003/0007 004/0017 007/0017 009/0017 010/0017 056X/0017 057X/0017 058X/0013 059X/0013 060X/0013 061X/0013 062X/0013 001/0008 002/0008 003/0008 004/0008 005/0008 006/0008 007/0008 008/0008 009/0008 010/0008 011/0008 012/0008 020/0008 021/0008 030/0008 056X/0008 058X/0008 059X/0008 060X/0008 061X/0008 062X/0008 063/0008 064/0008 068/0008 069/0008 070/0008 077/0008 095/0008 201/0008 209/0008 210/0008 211/0008 212/0008 220/0008 441/0008 449/0008 450/0008 461/0008	001/0017 002/0017 003/0017 004/0017 009/0017 010/0017 056X/0017 057X/0013-CA 058X/0013 059X/0013 060X/0013 061X/0013 062X/0013 001/0015 002/0015 003/0015 004/0015 007/0015 008/0015 009/0015 010/0015 056X/0015 441/0015 461/0015 001/0018 002/0018 003/0018 004/0018 009/0018 010/0018 056X/0018 001/0038 007/0038 056X/0038 201/0038 441/0038 461/0038 001/0029 007/0029 056X/0029 057X/0029-CA 441/0029 461/0029 001/0031 002/0031 003/0031 004/0031 007/0031 008/0031 009/0031 010/0031 056X/0031 001/0041 007/0041 056X/0041 441/0041 461/0041 001/0030 007/0030 056X/0030 441/0030 461/0030	001/0019 027/0019 056X/0019

Some combinations of actuator family/inscription couldn't be available as standard. Other combinations with special inscription are available on request.